

**CE SERIES**



**IC BUS<sup>®</sup>**  
**CE SERIES**







# UPTIME, ON TIME, EVERY TIME

**AT IC BUS, WE KNOW WHAT IT TAKES TO DRIVE FORWARD. WE ARE FOCUSED ON MAKING PRODUCTS THAT ARE BETTER AND DIFFERENT. INVESTING IN QUALITY, AND BUILDING A SCHOOL BUS THAT DRIVERS LOVE TO DRIVE.**

Parents, teachers and school boards all depend on our buses to reach their destination with iron-clad predictability. Our success in doing so is the result of listening to our customers and providing solutions. It's a partnership built on trust and a deep respect for the heady mission of transporting the most precious cargo on earth.







# ANSWERING THE BELL



At IC Bus, we're proud of our legacy of building the highest quality buses on the market. That's why we make sure that every part we engineer and every material we choose must stand up to the rigors of daily use. Because when the school bell rings, your buses need to be on the road, not the service bay.

## QUALITY

- ▶ Millions of dollars invested into the Tulsa manufacturing facility to enhance precision assembly
- ▶ Standard 16-gauge steel body and all-steel rub rail construction provide increased strength
- ▶ Threaded steel body frame construction interlocks roof bows, drip rail and roof stringers into a simple single frame unit
- ▶ Redesigned the side window design based on feedback from the field. Window is now easier to close and incorporates advanced water management features
- ▶ Traditional hard-drive rivet construction is based on 120% of FMVSS design strength requirements

## DURABILITY

- ▶ Wrap-around 12" rear bumper with through-the-bumper exhaust is bolted onto frame for added strength and easier repair
- ▶ All external electrical connectors are sealed and locked for longevity
- ▶ Rear and side emergency doors equipped with internal hidden hinges are not exposed to the elements, helping to prevent corrosion and freezing
- ▶ Naviflex stepwell improves corrosion resistance
- ▶ 13,500 - 21,000-lbs vari-rate spring capacity suspension (Rear Air Suspension available)

## SERVICEABILITY

- ▶ Best-in-class engine accessibility to access components such as the EGR cooler, rocker arm cover, air compressor, fuel system, exhaust manifold and turbo
- ▶ Best-in-class location of the fuel and water separator, as well as the transmission fluid fill and drain access
- ▶ Exterior electrical control panel improves accessibility to the electrical system for troubleshooting and after-market installations
- ▶ Programmable oil change light gives fleets the ability to customize parameters, including number of miles/kilometers run, hours of operation or gallons of fuel
- ▶ LCD on-board diagnostic display reports fault codes for engine and chassis without the need for a reader
- ▶ 3-piece flat roped-in windshield and roped-in stationary glass for easier and more cost-effective glass replacement
- ▶ CE Series features headlights that can be replaced without tools
- ▶ Wide-opening, easy-tilt three-piece fiberglass hood provides excellent engine access for routine maintenance





# SAFETY BEYOND REPROACH

IC Bus takes a comprehensive approach to the safety of our products. This approach has led us to develop innovative features that protect children, like the integrated front bumper crossing control gate, available Leave No Student Behind® system, steering-wheel-mounted door switches and the widest stepwell in the industry. In fact, the stepwell is positioned to be better aligned with the driver's field of view versus the competitors, which reduces neck strain and fatigue.

## CE SERIES SAFETY FEATURES

- ▶ Best-in-class 36" stepwell is better aligned with the driver's field of view versus the competitors and does not taper toward the top for easier and safer loading and unloading
- ▶ Long grab handles extend close to the ground and are reachable by even the smallest passengers
- ▶ Interchangeable SafeGuard BTI Seating
- ▶ Integrated front bumper crossing control gate helps to ensure that students do not cross in front of the bus
- ▶ Available Leave No Student Behind® feature ensures drivers disable alarm at rear of bus before exiting, ensuring no student is overlooked
- ▶ Available automatic traction control helps the driver maintain control on slick roads
- ▶ Bendix® ESP® stability system may help mitigate rollovers and loss of control on a wide variety of road conditions. Full stability systems like this one deliver more performance than roll-only systems, thanks to additional sensors and braking capability.



Interchangeable SafeGuard BTI seating exclusively for IC Bus® vehicles is continually compliance tested to make sure it meets and exceeds all federal safety standards

**WITH THE WIDEST STEPWELL IN THE INDUSTRY, THIS BEST-IN-CLASS DESIGN HAS A 35" OPENING AND FEATURES LONG GRAB HANDLES WHICH EXTEND CLOSE TO THE GROUND**

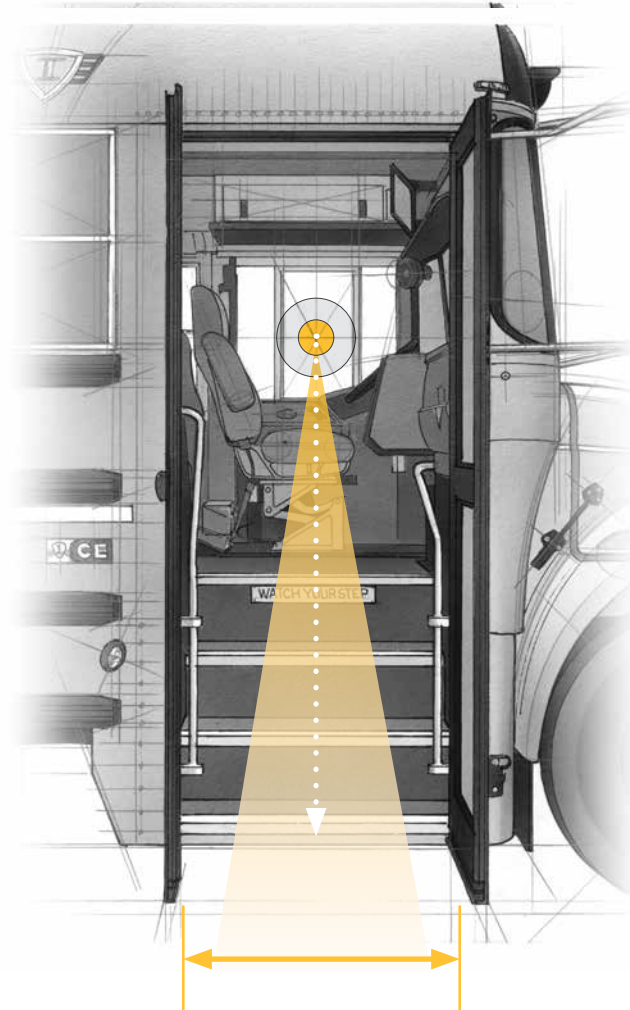

**35" OPENING ALIGNS WITH THE DRIVER'S FIELD OF VIEW**

# IC BUS FULL VIEW CAMERA TECHNOLOGY™ BY ROSCO

IC Bus is proud to offer the industry's first camera system designed specifically for school buses. Combined with the side mirrors, this advanced system will allow bus drivers to have a "full view" around the bus so they can concentrate on driving and keeping kids safe.

## FULL VIEW CAMERA FEATURES

- ▶ Co-developed with Rosco, IC Bus designed the industry's first purpose-built camera for a school bus application
- ▶ Provides drivers views based on the situation at hand, such as backing up, opening the door, or a view to the side or front of the bus
- ▶ This purpose-built camera technology is designed to not overload the driver with too much information, but instead provide them with the right information at the right time
- ▶ Gives the driver a greater feeling of security and peace-of-mind with the combination of the full view camera technology and driver mirrors
- ▶ Provides accurate visibility to the areas that matter most around the bus



Front View

Side View



Rear View



The Full View Camera System displays the most appropriate view based on the situation at hand, including backing up, opening the door, or the view of the front, side or rear of the bus.

## AUGMENTS EXISTING SAFETY FEATURES

## AVOIDS INFORMATION OVERLOAD WITH A FOCUSED INTUITIVE APPROACH

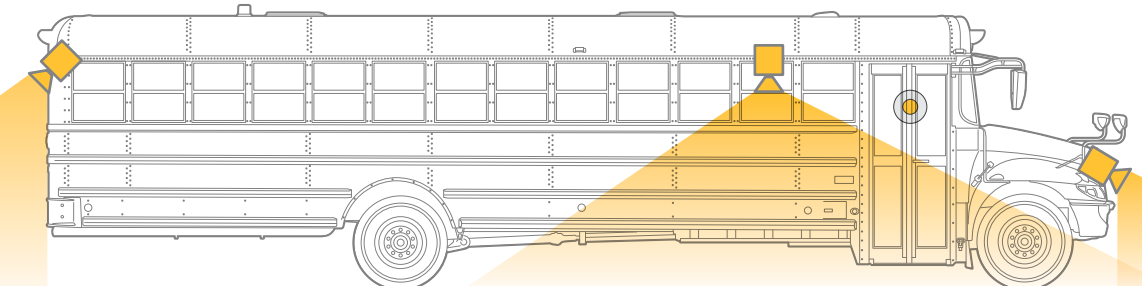

Camera System locations





# SETTING THE BAR

## THE ONLY OEM TO MAKE ESC-CM STANDARD



IC Bus® is proud to be the first in the industry to offer Collision Mitigation (CM) technology and Electronic Stability Control (ESC) as standard equipment. In fact, the CE Series is available with the most powerful driver assistance system currently available for the commercial vehicle industry. The system integrates various sensors and brakes into a comprehensive safety suite to help drivers mitigate collisions, rollovers and loss-of-control situations — potentially resulting in lower repair costs and greater peace of mind.

### BENEFITS OF ELECTRONIC STABILITY CONTROL

- ▶ Provides More Control on Slick Surfaces
  - ESC will automatically apply the appropriate brakes when loss of traction is detected
  - Acts in ways the driver cannot replicate using selective wheel brake control
  - May act before the driver realizes a situation exists
- ▶ Actively Helps the Driver Avoid or Recover from Rollover and/or Loss of Control Conditions
  - ESC will help correct the vehicle orientation by reducing speed and/or applying brake pressure to the appropriate wheels
- ▶ More Control
  - The system helps mitigate vehicle slides, skids, and loss of control through advanced monitoring of a variety of vehicle parameters and automatic and selective application of vehicle brakes



# THE IMPORTANCE OF FULL STABILITY

## ELECTRONIC STABILITY CONTROL (ESC)

ESC is a key component of this active safety system. Using sensors combined with the Anti-lock Braking System (ABS), ESC helps the driver maintain control during over-steer and under-steer situations on both wet and dry road surfaces reducing the chance of a roll-over. When the stability threshold reaches a critical level, the system can selectively apply vehicle brakes and even de-throttle the engine.

### DRIVING SCENARIO:

The vehicle's speed around a curve has exceeded the ability of the tires to hold the vehicle orientation, causing the vehicle to slide and over-steer.

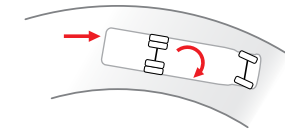

### SYSTEM RESPONSE:

ESC helps to correct the vehicle orientation by reducing speed and, if required, the system quickly applies braking pressure to the appropriate wheels.

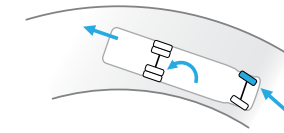

### DRIVING SCENARIO:

A vehicle enters a curve too fast on high friction pavement. The wheels and the pavement create a "hinge" effect allowing the forces at the center of gravity to push the vehicle over.

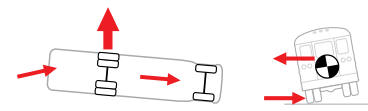

### SYSTEM RESPONSE:

ESC applies pressure to all brakes and reduces engine throttle to quickly reduce vehicle speed and help reduce the chance of a rollover.

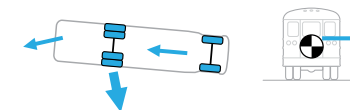

The table below identifies the key features and components of the Electronic Stability Control system:

	FEATURE	WHY IT MATTERS
Sensor Technology	Wheel Speed Sensors	Allows the system to determine vehicle speed and monitor wheel lock-up to optimize braking
	Lateral Acceleration Sensor	Side or lateral forces are used to detect a roll situation
	Steering Angle Sensor	An early indicator of a potential critical maneuver. Helps the system to respond faster and more accurately
	Brake Pressure Sensors	Allows the system to accurately supplement the driver throughout the maneuver
	Yaw Rate Sensor	Allows the system to monitor the true orientation of the vehicle and compare it to the driver's intention
Performance Enhancement	Multi-level Sensing	Improves the reaction time and accuracy of the intervention
	Tuning	Improves the ability of the stability system to match the intervention of the situation
	All Axle Braking	Provides the best opportunity to reduce vehicle speed in the shortest time
	Individual Corner Braking	Provides the capability to control under- and over-steer situations



# COLLISION MITIGATION FOR ALL

## KEEPING AN EYE ON THE ROAD AHEAD

IC Bus is the only OEM to offer both active and passive collision mitigation features as standard equipment to help the driver maintain a safe travel experience. Passive safety provides alerts that may require the driver to take action. Active safety automatically takes action to help avoid or reduces the severity of a potential collision, such as de-throttling the engine and applying the brakes.

One of the most advanced active safety features included on the CE Series is enhanced Collision Mitigation. This system uses radar and an optional video camera to scan the forward path of the bus. If a slower moving or stopped vehicle is detected, the system is designed to reduce the severity and likelihood of a rear-end impact by applying the brakes.

This integration of various technologies creates a highly detailed data picture which can significantly reduce the chance of a false alert or activation.

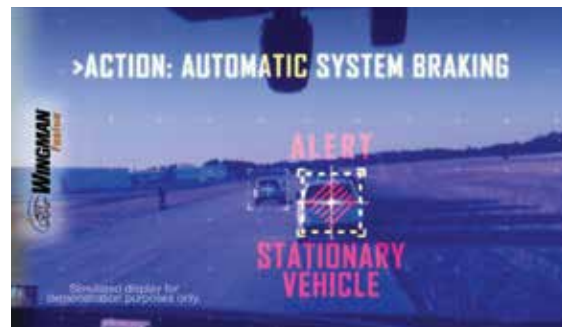

The CE Series can use the radar and a camera to detect objects about 500 feet in front of the bus.

### SYSTEM FEATURES

FEATURES	WHAT IT DOES...
<b>Stationary Vehicle Braking</b>	Provides alert and braking when system definitively identifies stationary car in lane
<b>Stationary Object Alert</b>	Helps reduce the likelihood of hitting a stationary object
<b>Collision Mitigation</b>	Helps reduce the frequency and severity of rear-end collisions
<b>Adaptive Cruise Control</b>	Helps driver maintain gap with forward vehicle
<b>Following Distance Alerts</b>	Helps reinforce a safer distance gap between host & forward vehicle
<b>Overspeed Alert &amp; Action</b>	Warns driver when speeding
<b>Lane Departure Warning</b>	Alerts the driver to unintended lane change - helps drowsy drivers
<b>Alert Prioritization</b>	Provides most critical alert first helping mitigate driver distraction from multiple alerts occurring simultaneously
<b>Impact Alerts</b>	Helps warn the driver that a collision with a forward vehicle is possible

## SUPPORTING SAFE DRIVING

### FOLLOWING DISTANCE ALERTS

The radar can also be used to maintain a safe following distance when the Adaptive Cruise Control is engaged. Radar has many advantages including the ability to read objects through all weather conditions such as rain, snow, smoke and fog.

### LANE DEPARTURE WARNING (available with camera)

The camera can detect if the bus unintentionally departs the lane without the turn signal activated and will sound an alarm and provide a visual alert. This is particularly valuable during driver distraction or drowsiness situations.

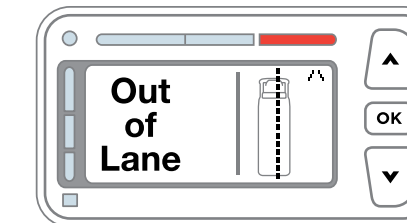

When an unintended lane departure is detected, an alert will sound.

### SITUATIONAL EXAMPLES

SITUATION	POSSIBLE CAUSE	HOW ACTIVE SAFETY CAN HELP
<b>Rear End Collisions</b>	Distracted Driver	Can reduce the likelihood or severity of rear-end accidents
<b>Overly Aggressive Drivers</b>	Bus is too close to the forward vehicle	Following Distance Alert will beep when following too closely
<b>Limited Sight in Poor Weather Conditions</b>	Snow, rain, smog, smoke, fog, sleet	Radar can see through most bad weather to alert the driver if needed
<b>Excessive Speed</b>	Traveling above posted speed limit on highways	Optional camera can recognize posted speed limits and alert the driver at +5 mph. +10 mph alert and 1.0 second engine dethrottle will occur

The CE Series integrates radar, camera and the vehicle's brakes, to help provide enhanced safety for today's North American commercial vehicles.

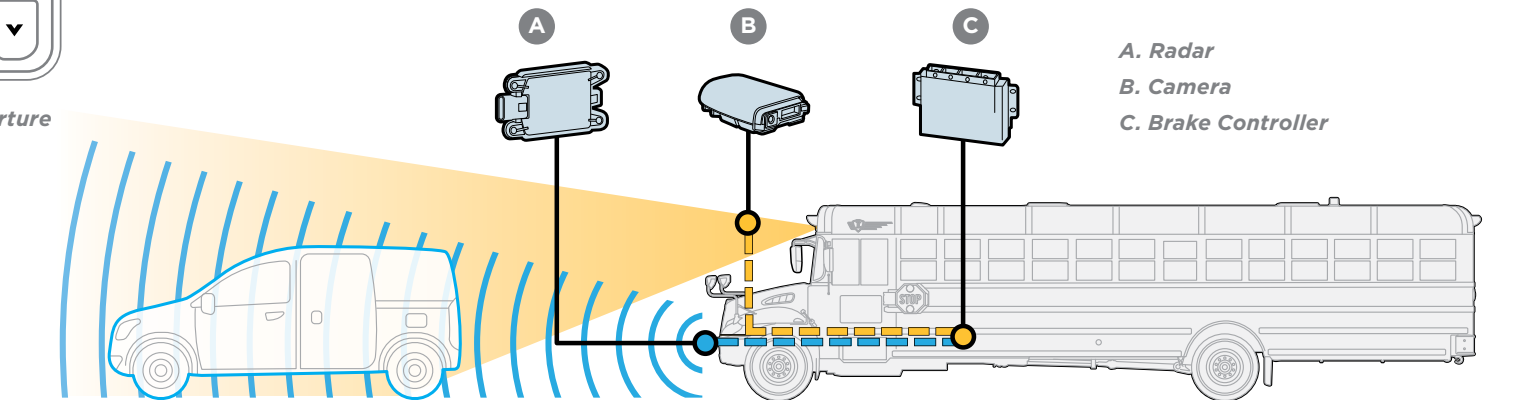

A. Radar  
B. Camera  
C. Brake Controller





# DRIVERFIRST™

## DESIGNED WITH DRIVERS IN MIND



- 1 Driver Seat Options**  
IC Bus offers a full range of driver seat options, from base to premium
- 2 Accessible Storage**  
Easy-to-reach storage compartment next to driver's seat helps the driver reduce clutter
- 3 Left Hand Switch Panel**  
Switch panel is located in front of the driver and allows the driver to maintain a forward-facing position ensuring safe operation
- 4 Standard Steering Wheel Controls (back lit)**  
Allows driver to keep their eyes on the road and hands on the wheel
- 5 Optimum Ergonomics**  
Cockpit accounts for the measurements of over 1,500 real school bus drivers to ensure optimal ergonomics and reduced driver fatigue
- 6 No Windshield Center Post**  
No center post to obstruct forward visibility
- 7 Widest Door in the Industry**  
The CE Series door is the largest among three major competitors for ease of loading and unloading
- 8 3-Piece Windshield**  
Absence of A-Pillar provides a clear view of the side mirrors
- 9 Ingress/Egress**  
Steps are consistently spaced and better aligned with the driver's field-of-view enhancing safety

## MISSION STATEMENT

As a leader in the bus industry, IC Bus knows that uptime is about being on time, every time, every day - but we also know that won't happen without committed drivers.

That's why we're putting the ones behind the wheel at the center of all we do. It's a philosophy we call DriverFirst™ and it has led to significant improvements in safety, ergonomics and efficiency.

We're stepping forward and taking the lead in the industry – embracing technology and innovation to make drivers more safe and satisfied, so they stay committed to driving our future with us.

**HELPING ALL STAKEHOLDERS IN THE INDUSTRY RECRUIT & RETAIN SCHOOL BUS DRIVERS**







# TAKE COMMAND

**THE MOST IMPORTANT FACTOR IN EVERY SAFE JOURNEY, IS A TRAINED BUS DRIVER. DRIVING AS MANY AS 78 CHILDREN TO AND FROM SCHOOL TAKES A DEFT TOUCH AND A LOT OF CONCENTRATION.**

The driver's cockpit of the CE Series has been carefully designed using the measurements of over 1,500 actual bus drivers to ensure maximum comfort, reducing driver fatigue.

## EASY-REACH DESIGN

- ▶ Driver cockpit accounts for actual measurements of over 1,500 real school bus drivers to ensure optimum ergonomics and maximum comfort – reducing driver fatigue
- ▶ Electrically activated entrance door to increase driver control during loading and unloading with standard vandal lock on electric door
- ▶ 8 lamp and entrance door switches placed on the steering wheel allow the driver to keep his/her hands on the wheel during loading/unloading situations



COCKPIT DESIGNED BY USING MEASUREMENTS OF OVER 1,500 REAL BUS DRIVERS TO ENSURE COMFORT AND REDUCE FATIGUE

# OVER 1,500 DRIVERS

## VISIBILITY – A NO COMPROMISE APPROACH

Maintaining a high level of visibility of the road and pedestrians is one of the most important factors in bus design. The CE Series includes many features designed to enhance visibility and put the driver in a position to succeed.

- ▶ Flat glass ensures no distortion in the corners
- ▶ Overlapping wiper pattern to ensure right hand mirror remains visible through cleared portion of windshield
- ▶ A greater percentage of the windshield is cleared than main competitors
- ▶ Unlike some competitive designs, the CE Series does not have an A-pillar that may interfere with the driver's view of the mirrors

The CE Series features a 3-piece windshield with individually replaceable sections to help avoid replacing an entire windshield in the event of damage. The windshield is also larger than the Bluebird, but not unnecessarily large like the Thomas design with much of the glass area extending above, and out of the driver's line of sight.

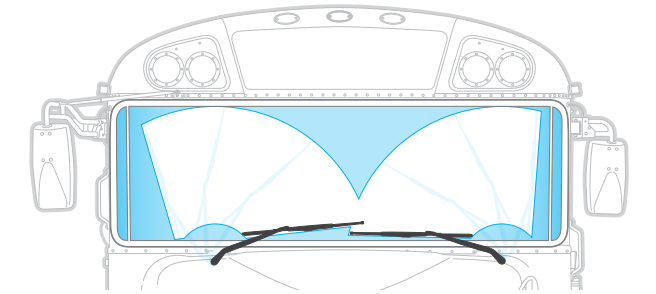

## CE SERIES VISIBILITY

Windshield Design	3-piece
Windshield Area (sq. in.)	2,458.0
Wiper Coverage (sq. in.)	1,369.0
Wiper Efficiency (%)	56%
Side Glass (sq. in.)	1,144
Rear Glass (sq. in.)	696.0
Total Glass (sq. in.)	22,087.5

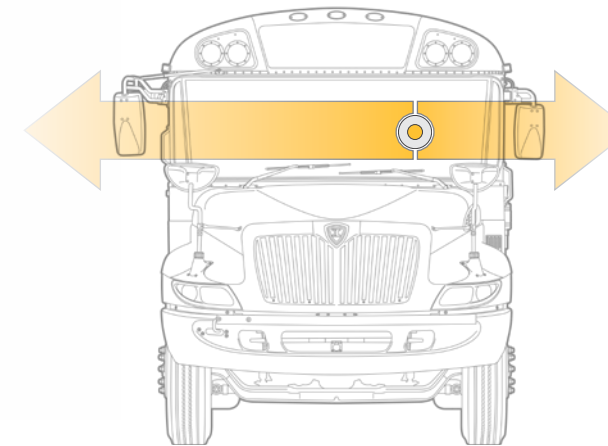

**UNLIKE SOME COMPETITIVE DESIGNS, THE CE SERIES DOES NOT HAVE AN A PILLAR THAT MAY INTERFERE WITH THE DRIVER'S VIEW OF THE MIRRORS**





# STRENGTH YOU CAN DEPEND ON



**AT IC BUS, WE'RE DRIVEN TO BUILD THE MOST RESILIENT, MOST RELIABLE BUSES IN THE INDUSTRY. THIS IS EVIDENCED BY OUR ENGINE OFFERINGS FROM REPUTABLE PARTNERS LIKE CUMMINS AND PSI, PLUS TRANSMISSIONS FROM EATON AND ALLISON.**

We've also given the CE Series best-in-class engine access with easy-to-see fluid compartments — all to keep you headed down the road.



## THE POWER OF CHOICE

Every bus driver knows that no two trips are the same. Having a reliable and powerful engine to get them through the day is one thing they should count on. CE Series offers three strong options: the PSI 8.8L Propane, the PSI 8.8L Gasoline and the Cummins® B6.7. No matter which engine suits your needs, you can be sure that rock-solid durability comes standard.



PROPANE TANK CAPACITIES:

**46-GALLON  
68-GALLON  
90-GALLON**



### DIESEL

- ▶ Reliable and efficient Cummins® B6.7
- ▶ 200-260 hp and 520-660 lb.-ft.
- ▶ VGT Turbocharger increases fuel economy and braking horsepower



### GASOLINE

- ▶ Purpose-built for school bus applications
- ▶ Low engine-speed design produces less noise, heat and wear for more durability
- ▶ Best-in-class accessibility for easy maintenance



### PROPANE

- ▶ Purpose-built design provides diesel-like performance with low emissions
- ▶ Smooth, quiet, reliable power
- ▶ Propane tank sizes (gallons): 46, 68, 90

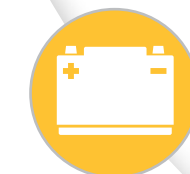

### ELECTRIC

- ▶ Zero emissions and lower cost of ownership
- ▶ Range will exceed 120 miles
- ▶ Estimated launch: 2019





# PSI 8.8L

**PURPOSE-BUILT FOR THE SCHOOL BUS INDUSTRY, PSI'S MEDIUM-DUTY 8.8L NATURALLY ASPIRATED ENGINE IS AVAILABLE WITH A GASOLINE OR PROPANE POWER UNIT DEVELOPED FROM THE BLOCK UP TO BE RELIABLE AND DURABLE.**



### CYLINDER HEADS

Modernized, heavy-duty, high-flow heads create fast burn to improve efficiency and reduce emissions

### CRANKSHAFT

Forged and induction-hardened steel crankshaft creates durable block capable of 1,000+ lb.-ft. of torque



### INTAKE MANIFOLD

Tuned long-runner provides higher torque and special air gap design keeps engine air cooler for improved efficiency

**RATED POWER:  
265-270 HP**

**RATED TORQUE:  
548-565 LB-FT**

### HEAVY-DUTY DESIGN

- ▶ Forged, induction-hardened crankshaft
- ▶ Forged rods and pistons
- ▶ Oil bath lubrication provides piston cooling
- ▶ Low engine-speed design produces less noise, heat and wear than competitor gasoline and propane engines

### SERVICEABLE

- ▶ Both the engine compartment and engine provide best-in-class accessibility for easy maintenance
- ▶ Gasoline and Propane versions use the same engine block providing an easy solution for mechanics and drivers of mixed fleets
- ▶ Includes the industry's only one-stop warranty for gasoline and propane vehicles

### ALLISON TRANSMISSIONS

- ▶ Shorter, sturdier shaft has increased durability (vs Ford)
- ▶ Over 44% more clutch material vs. Ford so it holds gear and lasts longer in the toughest operation
- ▶ Heavy-duty park pawl better secures vehicle
- ▶ Same transmission used across all IC Bus® powertrains for ease of maintenance

### PSI 8.8L V8 GASOLINE

Based on feedback from our customers, we set out to develop a gasoline-powered, commercial-grade V8 engine purpose-built for school buses that features similar power and performance to diesel. This means immediate acceleration from a complete stop and greater hill climbing capability. In other words: a no compromise solution for school districts everywhere.

#### PSI 8.8-LITER NA GASOLINE TECHNICAL SPECIFICATIONS

<b>Cylinders</b>	V-8
<b>Induction System</b>	Naturally Aspirated
<b>Combustion System</b>	Spark-ignited
<b>Displacement</b>	535 cid (8.767 L)
<b>Compression Ratio</b>	9.1:1
<b>Bore &amp; Stroke</b>	4.35 in x 4.50 in (110.5 mm x 114.3 mm)
<b>Rated Power</b>	265 hp (197.6 kw)
<b>Rated Torque</b>	548 lb.-ft. (743 nm)
<b>Cooling System</b>	Water-cooled
<b>Engine Coolant Capacity</b>	16 qts
<b>Engine Oil Capacity</b>	7.0 qts (6.62 L)
<b>Engine Oil Capacity (with filter)</b>	7.5 qts (7.10 L)
<b>Direction of Rotation</b>	Clockwise From Front
<b>Fuel Type</b>	Gasoline
<b>Dry Weight</b>	748 lb. (339 kg)

### PSI 8.8L V8 PROPANE

PSI's high-performance V8 can handle the rigors of on-road duty delivering a clean-technology solution without sacrificing power or performance. Superior engine performance is driven by an ECU that integrates and coordinates all critical functions including governor, variable ignition timing, air/fuel ratio control, knock suppression and engine protection.

#### PSI 8.8-LITER NA LPG TECHNICAL SPECIFICATIONS

<b>Cylinders</b>	V-8
<b>Induction System</b>	Naturally Aspirated
<b>Combustion System</b>	Spark-ignited
<b>Displacement</b>	535 cid (8.767 L)
<b>Compression Ratio</b>	10.1:1
<b>Bore &amp; Stroke</b>	4.35 in x 4.50 in (110.5 mm x 114.3 mm)
<b>Rated Power</b>	270 hp (201 kw)
<b>Rated Torque</b>	565 lb.-ft. (766 nm)
<b>Cooling System</b>	Water-cooled
<b>Engine Coolant Capacity</b>	16 qts
<b>Engine Oil Capacity</b>	7.0 qts (6.62 L)
<b>Engine Oil Capacity (with filter)</b>	7.5 qts (7.10 L)
<b>Direction of Rotation</b>	Clockwise From Front
<b>Fuel Type</b>	Propane
<b>Emissions Certification</b>	US EPA & CARB HD-SI
<b>Dry Weight</b>	748 lb. (339 kg)





# CUMMINS® B6.7

EVERY ASPECT OF THE B6.7 HAS BEEN ENGINEERED FOR RELIABILITY, DURABILITY AND FUEL EFFICIENCY TO DELIVER THE LOWEST COST OF OWNERSHIP WITH MAXIMUM UPTIME.



**RATED POWER (MAX):**  
**260 HP** | **RATED TORQUE (MAX):**  
**660 LB-FT**

## KEY HIGHLIGHTS

- ▶ Variable Geometry Turbocharger (VGT) delivers superior performance under all operating conditions
- ▶ Electronic controls provide enhanced thermal management of the aftertreatment system (eliminates need for variable valve timing)
- ▶ 2017 single module has up to 70% reduction in space claim and up to 30% reduction in weight when compared to the 2009-2016 switchback system
- ▶ Largest network of trained and certified technicians in the world
- ▶ Well established distribution centers ensure parts are widely stocked for best-in-class availability
- ▶ Available with an Eaton or Allison Transmission

## EATON® PROCISION™ TRANSMISSION

- ▶ Creep mode allows controlled, low-speed maneuverability to give drivers and parents peace of mind
- ▶ Hill Helper prevents roll back or forward for up to 3 seconds, based on grade and vehicle weight, for a controlled and safe launch
- ▶ Dual-clutch technology preselects the correct gear for smooth delivery of power
- ▶ New Eaton synthetic transmission fluid enables 150,000-mile lube & filter changes for reduced maintenance costs



## CUMMINS® B6.7L DIESEL

The B-Series has an impressive legacy of over 30 years in production and over 12 million engines produced. Throughout its history, the B6.7 has been consistently updated for improved performance and efficiency. The end result is an engine that delivers uptime, big time.

### CUMMINS® B6.7 DIESEL TECHNICAL SPECIFICATIONS

<b>Engine Type:</b>	Diesel, 4-Cycle
<b>Configuration:</b>	Inline 6-Cylinder
<b>Displacement:</b>	409 cu. in. (6.7L)
<b>Bore and Stroke:</b>	4.21 X 4.88 in
<b>Aspiration:</b>	Variable Geometry Turbocharger
<b>Combustion System:</b>	Direct Injection
<b>Engine Lubrication:</b>	15L
<b>Total Engine Weight (Dry):</b>	1,150 lbs.
<b>Horsepower:</b>	200-260 hp
<b>Torque:</b>	520-660 lb.-ft.





# DIAMOND LOGIC<sup>®</sup> AND ONCOMMAND<sup>®</sup>

**IC BUS IS A PROVEN LEADER IN EMBRACING THE MOST INNOVATIVE TECHNOLOGIES FOR THE BUS INDUSTRY.**

Diamond Logic<sup>®</sup> includes numerous programmable features that help promote safe and responsible operation of the vehicle including the No Student Left Behind<sup>®</sup> feature and pre-trip inspection tools. OnCommand<sup>®</sup> provides a complete suite of service solutions to help you schedule regular service appointments, track maintenance history or find and order the parts you need. These beneficial technologies can help you lower the cost of vehicle ownership and increase the life cycle value of your bus.

## DIAMOND LOGIC

- ▶ Includes the ability to program available body integration and driver efficiency features, plus the ability to further customize to address specific application needs
- ▶ Service has easy access inside & out for ease of installing incremental features
- ▶ Common uses include: No Student Left Behind; exterior light check for pre-trip inspections; lights on with windshield wipers

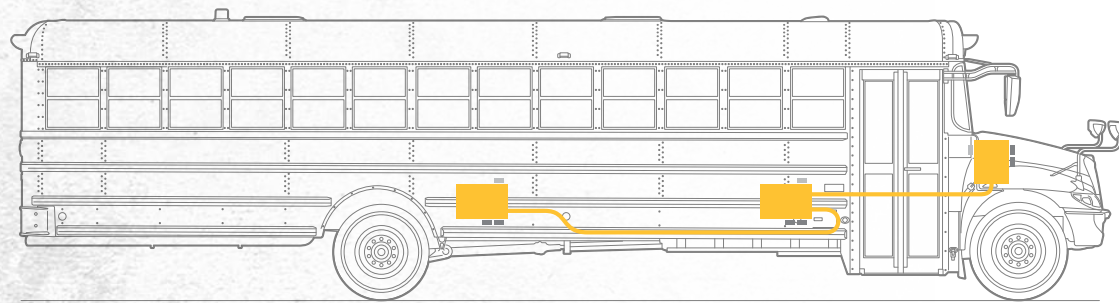

*IC Bus pioneered the best-in-class Diamond Logic electrical system. It includes numerous programmable features which are available factory-installed.*



## HELPING KEEP YOUR FLEET ON TIME, ALL THE TIME

As a manager of bus fleets, we know your biggest challenges. Ensuring passenger safety. Staying on schedule. Reducing operational costs and increasing efficiency. We're here to help. OnCommand<sup>®</sup> Connection is the first and only all-makes diagnostics system that connects your entire fleet and provides you with the information you need to get your job done.

## ONCOMMAND CONNECTION'S MISSION

- ▶ Improve vehicle reliability for your entire fleet
- ▶ Ensure the safety of your driver and passengers
- ▶ Increase the efficiency of your operation
- ▶ Reduce your costs and increase your value

## ONCOMMAND CONNECTION HELPS:

- ▶ Automate Driver Vehicle Inspection reports to make them faster and more accurate
- ▶ Merge inspection report data with vehicle fault codes into one easy to read report
- ▶ Be more proactive in identifying maintenance issues and addressing them before a breakdown occurs
- ▶ Make informed choices to manage your fleet for maximum productivity

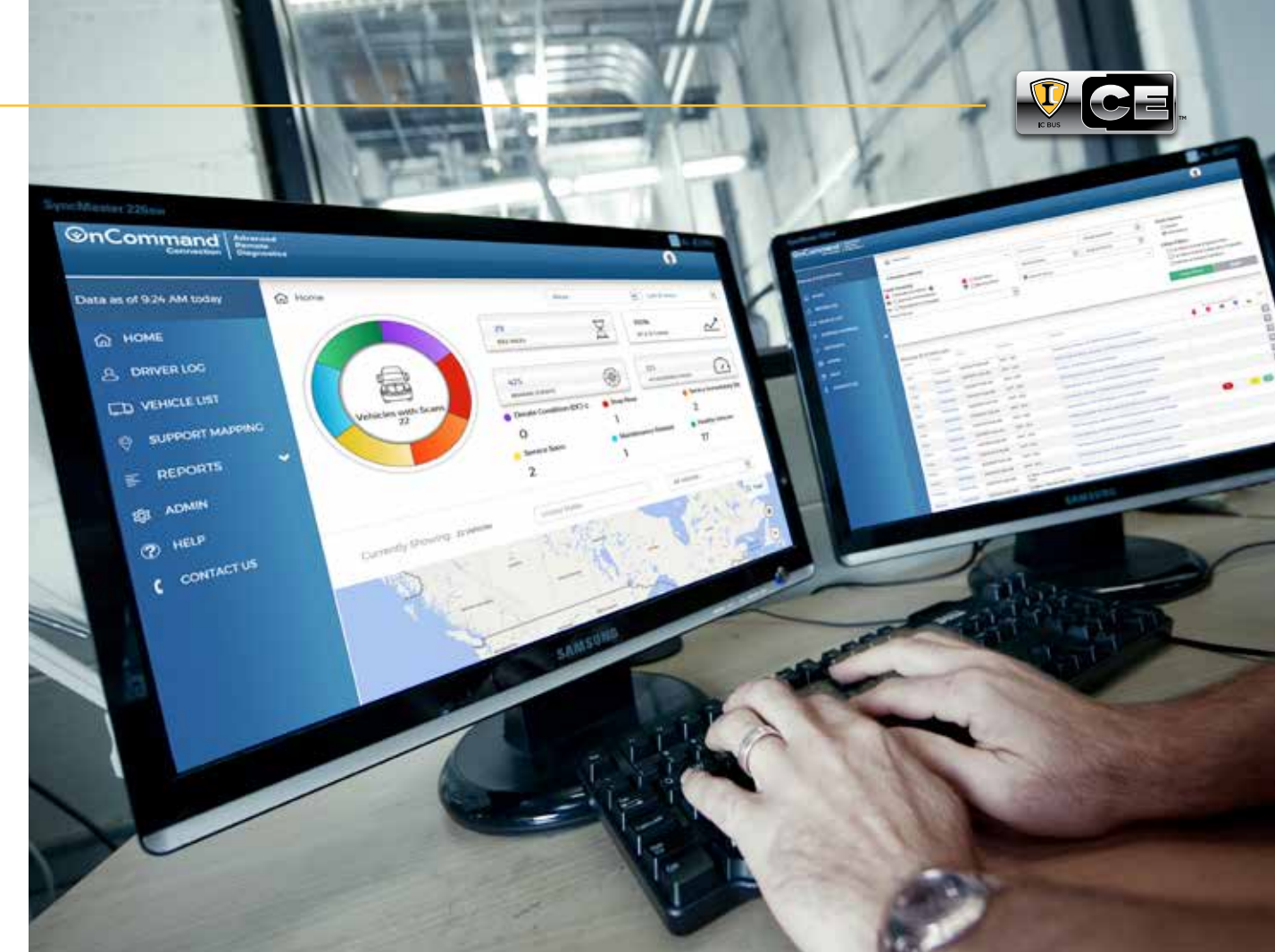

## REMOTE DIAGNOSTICS FOR ALL MAKES OF VEHICLES



**MERGE** vehicle fault code data with driver inspection reports for a complete view of vehicle health



**INTEGRATE** vehicle diagnostics with routing/scheduling products such as Edulog



**EVALUATE** driver behavior on data points like speeding, harsh braking, etc.\*

\* Enable by GPS or OCC telematics



**UNDERSTAND** vehicle fault codes quickly and easily with descriptions in plain English



**GAIN INSIGHTS** with fault code action plans that provide severity information and recommended solutions

## ALL THE TOOLS YOU NEED AT YOUR FINGERTIPS

OnCommand Connection is designed to keep your fleet on time and your passengers safe through powerful features such as **automated driver vehicle inspection reports, engineer-designed action plans and access to your portal** through your preferred interface: computer, tablet, smartphone or email.





# CE SERIES SPECIFICATIONS

**AT IC BUS, WE KNOW WHAT IT TAKES TO DRIVE FORWARD. WE ARE FOCUSED ON MAKING PRODUCTS THAT ARE BETTER AND DIFFERENT. INVESTING IN QUALITY, AND BUILDING A SCHOOL BUS THAT DRIVERS LOVE TO DRIVE.**

**The CE Series was engineered from the tires up to withstand the rigors of daily use and arrive at every destination on time, every time. Whether you're choosing diesel, propane or gasoline, IC Bus has built an unmatched portfolio of engine offerings to provide you with the freedom of choice.**

Additionally, IC Bus provides the tools and resources to enable you to operate as efficiently as possible, and have numerous product features that allow mechanics to more easily maintain and repair buses. After all, the safe delivery of our children is a team effort and no one understands this more than IC Bus.



## KEY HIGHLIGHTS

- ▶ Standard Leave No Student Behind® feature ensures drivers disable alarm at rear of bus before exiting
- ▶ Entry steps are consistently spaced for predictable footing and are the widest in the industry
- ▶ Standard 16-gauge steel body and all-steel rub rail construction provide increased strength
- ▶ LCD on-board diagnostic display reports fault codes for engine and chassis without the need for a reader
- ▶ 3-piece flat roped-in windshield and roped-in stationary glass for easier and more cost-effective glass replacement
- ▶ Electrically activated passenger door with standard electric vandal lock on entrance door
- ▶ Interchangeable BTI Seating features precision die-formed seat base and seat back
- ▶ Wide-opening, easy-tilt three-piece fiberglass hood provides excellent engine access for routine maintenance

**CAPACITY:**  
**29-78**  
**PASSENGERS**

## CE SERIES SPECIFICATIONS

### GVWR

- ▶ 23,500 - 33,000 lbs.

### CAPACITY

- ▶ 29 - 78 passengers

### Wheelbase Options

- ▶ 158", 169", 193", 217", 236", 254", 276"

### Single Rear Axle (4X2)

- ▶ Meritor: 15,500 - 23,000 lbs.
- ▶ Dana Spicer: 15,500 - 23,000 lbs.

### Front Axle

- ▶ Meritor: 8,000 - 10,000 lbs.
- ▶ Dana Spicer: 8,000 - 10,000 lbs.
- ▶ Navistar Select: 8,000 - 10,000 lbs.

### Frame

- ▶ High Strength Low Alloy Steel 50,000 PSI

### Front Suspension

- ▶ Parabolic Taper Leaf: 8,000 - 10,000 lbs.

### Rear Suspension

- ▶ International® Vari-Rate Spring: 13,500 - 21,000 lbs.
- ▶ International Ride-Optimized Suspension (IROS Air): 15,500 - 23,000 lbs.

### Electrical System

- ▶ Alternators
  - Leece-Neville: 12 Volt, 210 - 325 Amp
  - Delco Remy: 12 Volt, 200 Amp
- ▶ Battery Systems
  - Enersys Odyssey: 12 Volt 3450 CCA
  - JCI: 12 Volt 2850 CCA
  - Fleetrite® 8D: 12 Volt 1150 - 2300 CCA

### Exhaust System

- ▶ Single Horizontal Aftertreatment Device frame mounted under right rail

### Brakes

- ▶ Hydraulic Brakes with ABS and ATC
- ▶ Optional Air Brakes with ABS and ATC
- ▶ Air Drum Brakes and Air Disc Brakes

### Engines

- ▶ Diesel
  - Cummins® ISB 6.7: 200 - 260 hp, 520 - 660 lb.-ft.
- ▶ Propane
  - Power Solutions International (PSI) 8.8L: 270 hp, 565 lb.-ft.
- ▶ Gasoline
  - Power Solutions International (PSI) 8.8L: 265 hp, 548 lb.-ft.

### Transmissions

- ▶ Allison (5 or 6 speed): 2500 PTS with Direct Mount Cooler
- ▶ Allison (5 or 6 speed): 3000 PTS with Direct Mount Cooler
- ▶ Eaton® (7 speed): Procision™, Dual-Clutch Automated Manual

### Fuel Tanks

- ▶ 40 - 100 Gallons, mounted between frame and behind rear axle

### Exterior

- ▶ Standard Crossing Control Gate
- ▶ Automatic Headlights (optional)
- ▶ Electronic Stability Control and Collision Mitigation

### Interior

- ▶ 78" interior headroom
- ▶ Lighted steering-wheel mounted door control and eight-way light switches
- ▶ Water In Fuel Sensor
- ▶ Available Cruise Control
- ▶ Optional factory-installed IC Air
- ▶ Entrance door stepwell — 14 ga Steel, Formed Treads, Naviflex™ Finish — Standard
- ▶ Leave No Student Behind®







# WE HAVE YOUR BACK SO YOU CAN KEEP MOVING FORWARD

Your IC Bus dealer is one of the best in the business, and a strong link in the industry's broadest, most capable parts distribution and dealer network.

YES, WE'RE  
**OPEN**

Saturday  
**475+**  
Locations

Sunday  
**45+**  
Locations

**7,600+**  
TECHNICIANS

**7,400+**  
SERVICE BAYS

So no matter where you're located, you're not far from one of our

**700+**  
DEALER LOCATIONS

Leading all competitors in

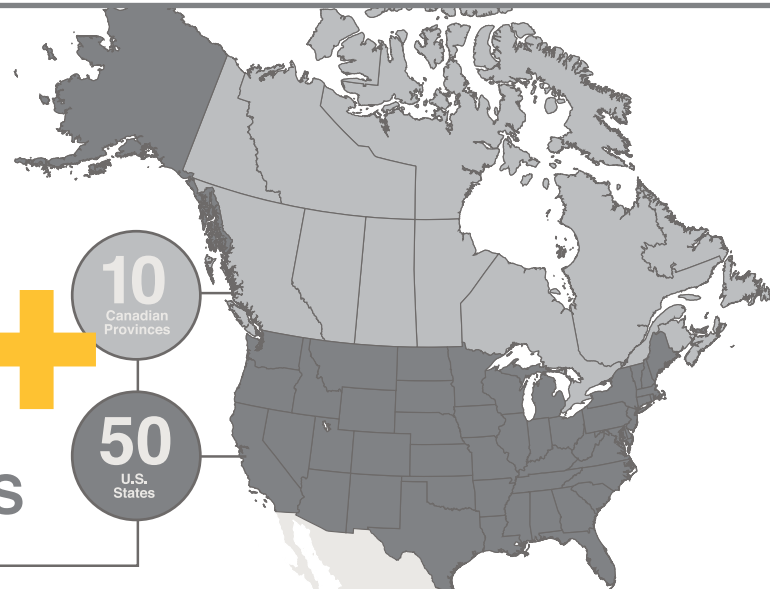

**NAVISTAR**  
CAPITAL  
a BMO Financial Group program

**FLEETRITE**



**DIAMOND EDGE<sup>SM</sup> CERTIFIED IC Bus Dealers**

Navistar Capital is an industry leader in commercial vehicle financing with over 40 years of experience. We provide customized leases and secured loans with flexible structuring for International<sup>®</sup> heavy and medium duty commercial vehicles. Contact your local International Truck dealer for more information.

For more than 40 years, Fleetrite<sup>®</sup> Parts have provided quality parts for all truck and bus makes sold exclusively at your International Truck dealer. Every part is Navistar quality approved and is covered under a 1-year parts and labor warranty. Parts you can trust and affordability you can bank on.

This select network of International dealer service departments has passed rigorous parts and service certification guidelines to provide you with faster turnarounds, immediate parts availability and a higher level of servicing expertise. Their ongoing pledge is to maximize your uptime and deliver a best-in-class customer experience.





[www.ICBus.com](http://www.ICBus.com)

Specifications, descriptors and illustrative material in this literature are accurate as known at time of publication, but are subject to change without notice. Illustrations may include optional equipment and accessories, and may not include all standard equipment. IC Bus, OnCommand, International, Diamond Logic, Fleetrite, DriverFirst, IC Bus Full View Camera Technology, Diamond Edge are all trademarks or service marks of Navistar, Inc. BAD18001

© 2018 Navistar Inc. All rights reserved. All marks are trademarks of their respective owners. Lithographed in the United States of America.